

L. Hannawald
 Technical University Dresden, Chair of Automotive
 Engineering and Transmission Technology,
 Dresden, Germany

Computerized Case by Case Analysis for Evaluation of Primary Safety Systems Regarding Accident Prevention

Abstract

Because of actual developments and the continuous increase in the field of drive assistant systems, representative and detailed investigations of accident databases are necessary. This lecture describes the possibility to estimate the potential of primary and secondary safety measures by means of a computerized case by case analysis. Single primary or secondary safety measures as well as a combination of both are presented.

The method is exemplarily shown for the primary safety measure "Brake Assist" in pedestrian accidents.

Regarding accident prevention only the primary safety measure is determined.

Primary and Secondary Safety

Real world accident data are mostly focused on the technical and medical description of accident scenarios and outcome. They are excellently suitable to indicate the benefit and for developing secondary safety measures. Secondary safety measures especially for pedestrians have positive effects regarding injury severity mitigation but they are not able to prevent accidents. Therefore primary safety systems, especially regarding the prevention of accidents, are gaining more and more importance. The scientific wording "primary safety" indicates that such measures have to be implemented with highest priority.

A sensible combination of primary and secondary safety measures is a promising way to go. Another important fact is that a combination of primary and secondary safety measures is able to operate independently.

Accident situations where the possible effect of any secondary safety measures is limited (e.g.

pedestrian impacts with overrun, side impact etc.), still effort the benefit from primary safety measures. Additionally primary safety measures can influence the accidents in any speed range.

On the other hand secondary safety still has an effect if primary safety measures can not be activated with current technology (e.g. driver does not brake, no benefit with current brake assist systems).

Computerized Case by Case Analysis¹

A computerized case by case analysis, instead of conventional single case analysis, is an important tool for representative statistical evaluations and objective results. This method is able to combine the advantages of single case analysis and virtual prototyping. It can not only help to find out significant influences due to accident causation and injury prevention, further therewith it is possible to determine benefits of existing primary and secondary safety measures or to predict the potential of future measures or systems regarding traffic safety.

This lecture shows exemplarily for pedestrian accidents the effect of the primary safety system "brake assist" with regarding to accident prevention.

Injury Risk Funktion

Injury risk functions help to understand the relation between injury severity and load criteria. For pedestrian accidents an injury risk function for the Maximum Abbreviated Injury Scale (MAIS) versus the collision speed was required.

The injury risk functions were calculated using the logistic regression method in order to describe the injury severity of the pedestrians with a mathematical formula. Therefore always a binary classification (e.g. more/equal MAIS₂→(1) and less MAIS₂→(0)) is necessary. An example of the average for each speed band is shown in Fig. 1 as a field of points.

To differentiate between the severity classes slightly, seriously and fatally injured, the correlation

¹ BECKER, BUSCH: Volkswagen AG, 2003, "Methods for the evaluation of primary safety measures"

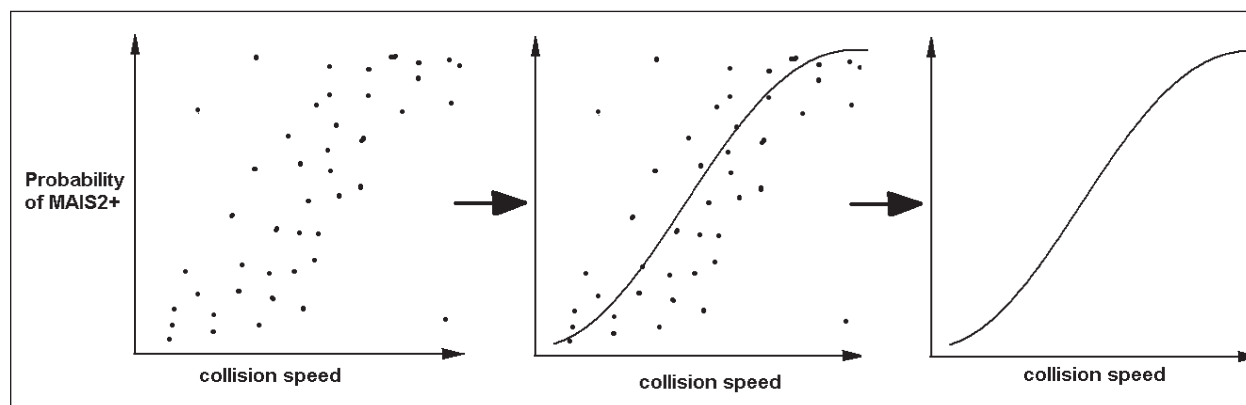

Fig. 1: Calculation of IRF using logistic regression method

between MAIS2+ and “at least seriously injured” and also MAIS5+ and “fatally injured” is shown in Fig. 2. This function gives a probability of being injured at a given MAIS level or otherwise delivers a classification of all cases at one collision speed of sustaining an injury of certain severity level (e.g. MAIS2+) or not.

Pedestrians with a MAIS2 to 4 were considered to be severely injured, those with a MAIS5 and 6 were considered as fatally injured, respectively.

Additionally it is possible to calculate the probability for pedestrians to be slightly, seriously or fatally injured depending on the collision speed, using the curves of MAIS2+ and MAIS5+ (Fig. 3).

The probability to be slightly injured as a pedestrian decreases in higher collision speed while the probability to be at least seriously injured increases. In each collision speed the sum of all probabilities has to be 100%. For example (Fig. 3), the probability for a pedestrian, impacted at collision speed of 40km/h, is approximately 30% to be slightly injured (MAIS1), 70% to be at least seriously injured (MAIS2+).

This injury risk function is based always on the same dataset used for the analysis. This fact assures, that there will be no bias due to different bases. Moreover it is possible to verify the injury risk function. For all cases in the analysis the collision speed is known and the probability of injury severity for each case could be calculated using the IRF. The sum of all predicted probabilities of at least seriously injured pedestrians should be equal to the original number of seriously and fatally injured pedestrians in the dataset. This possibility was stated as a requirement in the logistic regression analysis, so that the approximated

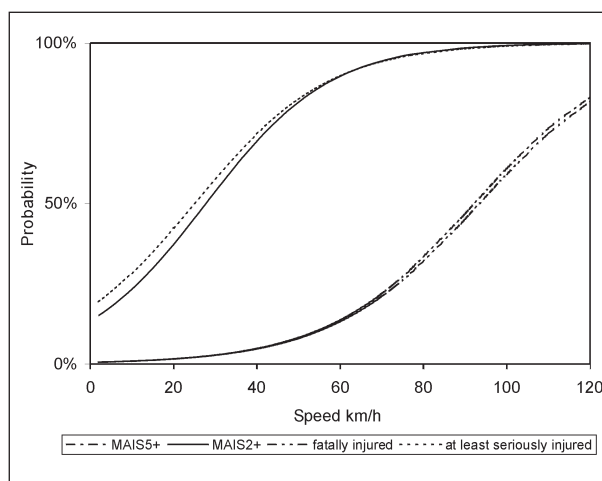

Fig. 2: Correlation between injury severity classes and maximum abbreviated injury scale

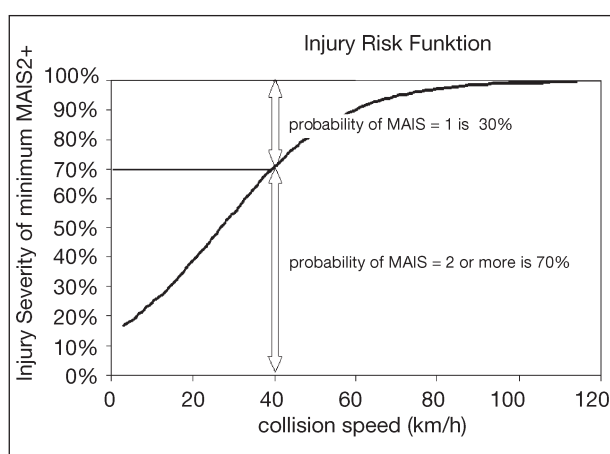

Fig. 3: Description of injury risk function

numbers of seriously and fatally injured pedestrians in the IRF are the same as the original number in the dataset. This requirement ensures accuracy for the results and minimizes the fault rate.

Effects of Primary and Secondary Safety

The possible effects of primary (BAS) and secondary safety measures are shown in Fig. 4 and Fig. 5. Secondary safety measures can reduce the injury severity of pedestrians. Therefore the effect

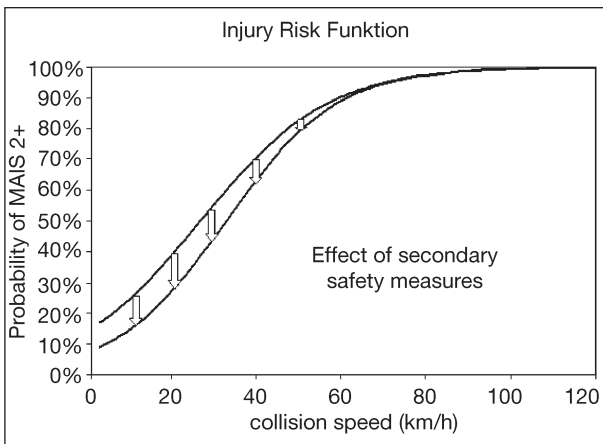

Fig. 4: Assumed influence of secondary safety measures regarding injury risk

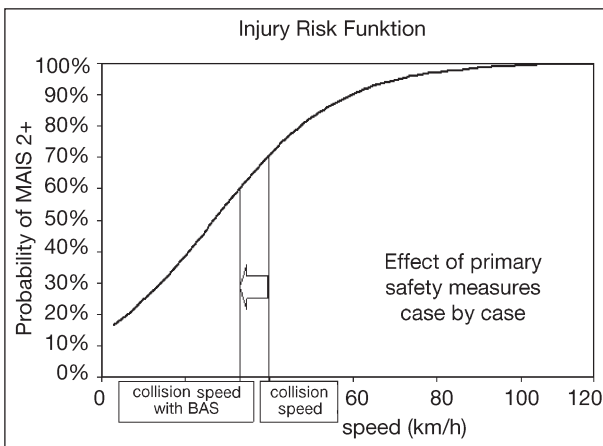

Fig. 5: Influence of BAS regarding injury risk

is a decrease of the injury risk for e.g. MAIS2+ injury severity.

On the other hand, the primary safety measure BAS has an influence on the collision speed. This influence does not directly change the injury risk function, but the collision speed as input of this IRF. In computerized case by case analysis the effect of BAS on collision speed can be predicted (Fig. 5). The overall probability of MAIS2+ injuries decreases with the reduction of the collision speed.

Current Situation

The current situation with the actual dataset was represented by an injury risk function. This was necessary for the following comparison. Therefore the real collision speed and the MAIS of the pedestrians were taken into account (Fig. 6, Fig. 7).

The probability of the injury severity class is calculated for each case using the collisions speed. The sum of all probabilities in each severity class results in the number of pedestrians in the dataset (Fig. 8).

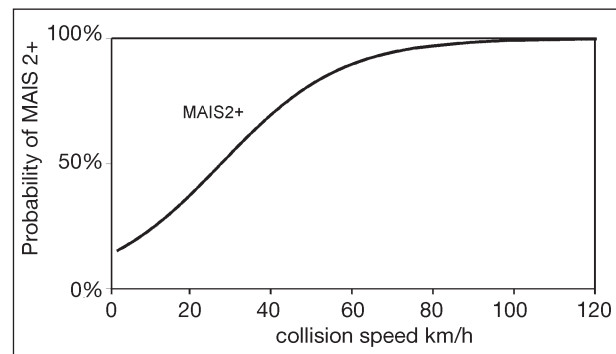

Fig. 7: Current situation – IRF

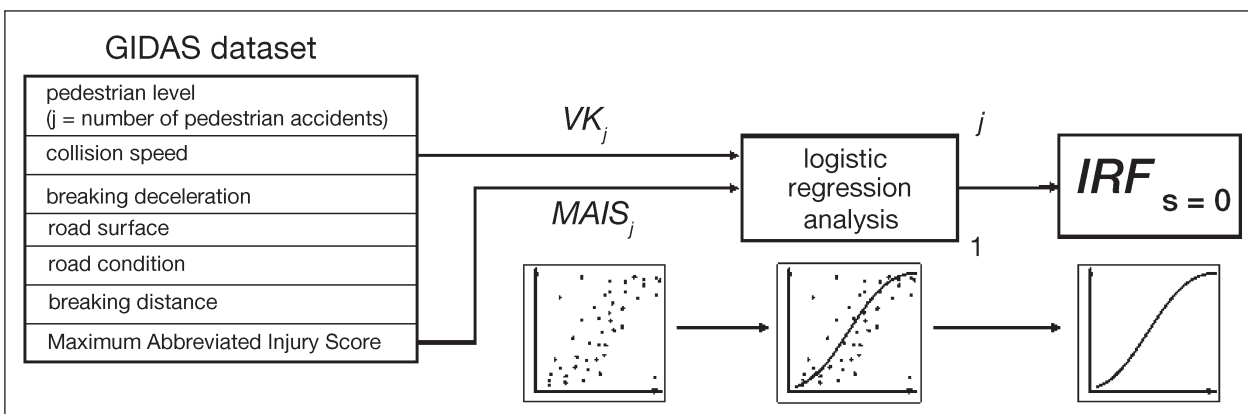

Fig. 6: Current situation – determination of IRF

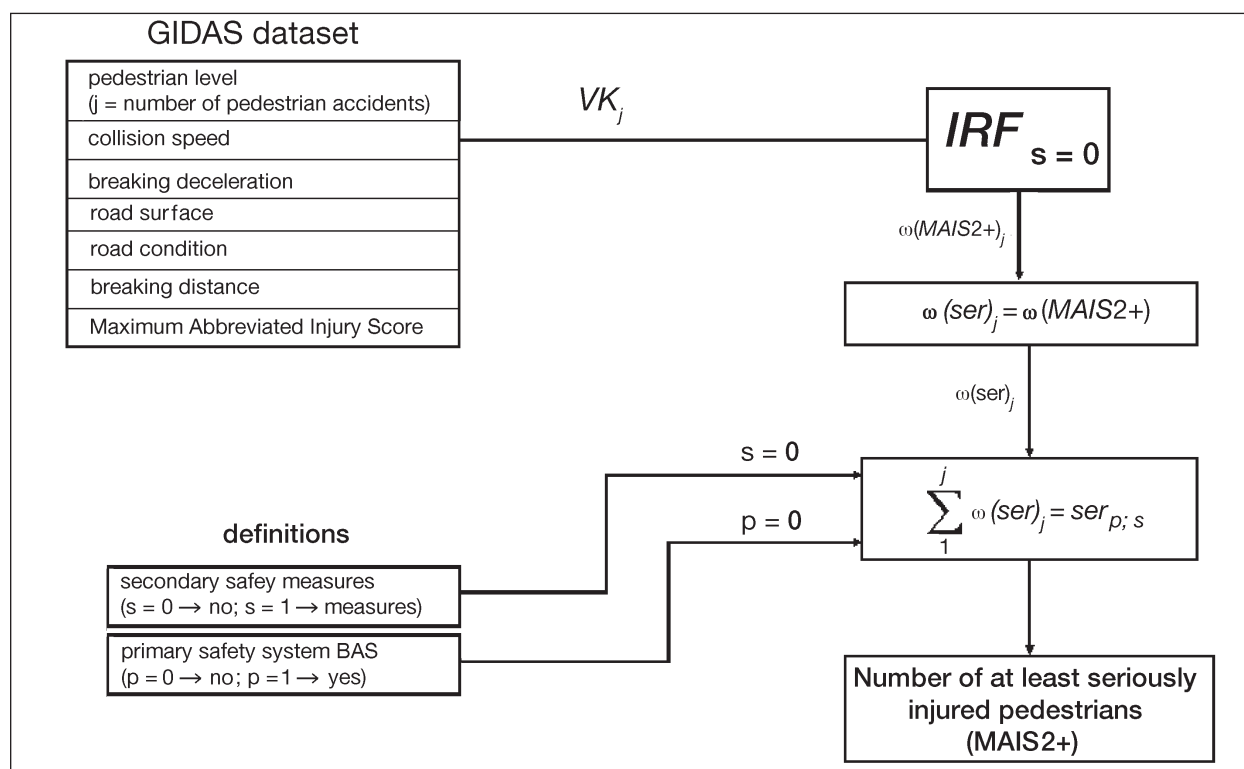

Fig. 8: Current situation – number of at least seriously injured pedestrians

Situation after Implementation of “Brake Assist”

Previous investigations suggest that the Brake Assist System (BAS) has an important influence on the avoidance of accidents.

Different crash research studies found, that although drivers reacted quickly in critical situations, they did not apply the brakes with sufficient force to achieve the highest possible deceleration. Most of the drivers who participated in the tests either could not make up their minds to brake with full force, or simply reacted incorrectly. Under normal braking conditions as well as under emergency conditions, they start out with little brake pressure and whenever necessary they will increase their pedal effort. In an emergency this behaviour can lead to a crash since valuable time (or, distance) is lost.

This finding was the rationale for developing the Brake Assist System. BAS is a controlled system helping to reduce braking distances by recognising the intent of the driver to do an emergency stop and initiating full braking within a fraction of a second. This can reduce braking distance substantially. In other words most drivers do not use the performance of the brakes – BAS automatically optimises it.

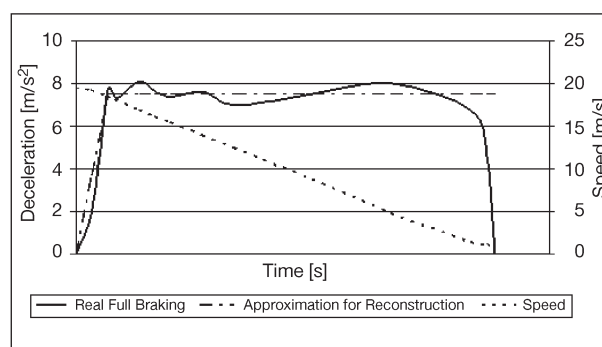

Fig. 9: Deceleration during a full brake current situation without BAS

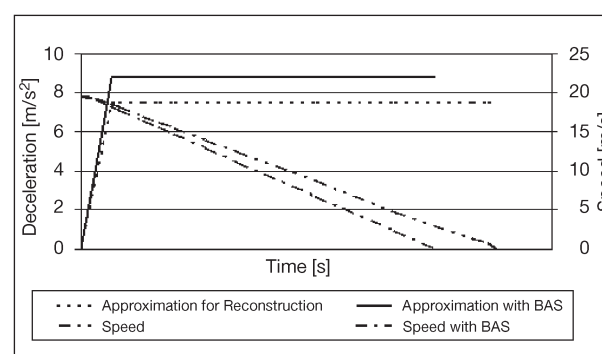

Fig. 10: Deceleration during full brake with and without BAS

Time histories of deceleration and speed are shown in Fig. 9.

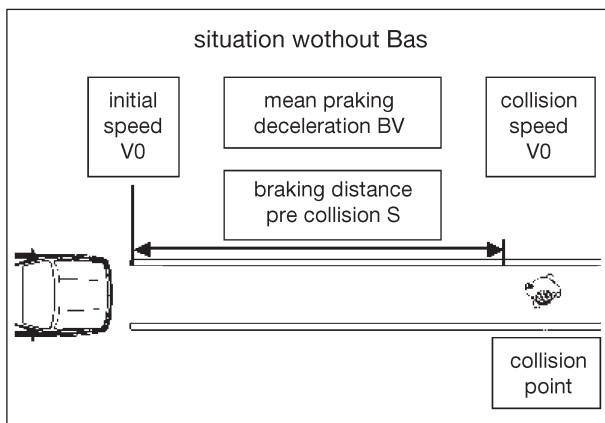

Fig. 11: Variables of accident reconstruction

All accidents scenarios in the GIDAS database are reconstructed as described regarding the initial speed, the mean braking deceleration, the braking distance pre-collision and the real collision speed (Fig. 11).

Especially the mean braking deceleration is mostly estimated using forensic literature. Based on this literature the road surface (e.g. asphalt, concrete) and the road conditions (e.g. dry, humid, wet) are important influence factors. Furthermore they declare that current vehicles equipped with antilock systems could reach a mean braking deceleration of 10–20% higher than described in the literature. Since all new vehicles will be equipped with these systems the estimated mean deceleration is always near the ceiling.

Both road surface and road condition are available in the GIDAS dataset and can be used to predict maximum possible braking deceleration if the car will be equipped with BAS.

To identify the intent of the driver to do an emergency stop, mostly the brake pedal speed, the brake pedal pressure or a combination of both is used.

The only variable in the dataset which quantifies the braking characteristics of the driver is the mean braking deceleration. Given a conservative approach the minimum of $6,0\text{m/s}^2$ mean braking deceleration was required to assume BAS activation. With this high threshold every real system would be activated. Setting the activation threshold this high also compensates for neglecting the influence of pedal speed. With this threshold of more than $6,0\text{m/s}^2$ in 47% an activation of BAS is predicted. This rate for activation of the BAS concurs with driving simulator tests.

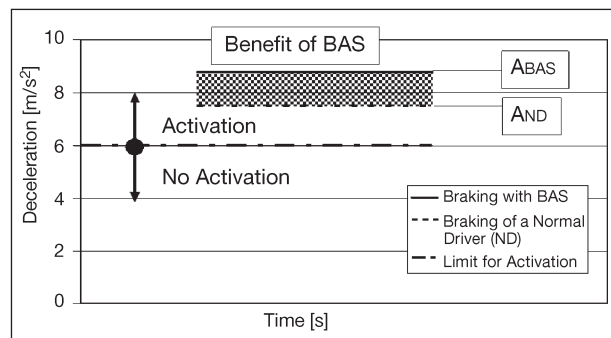

Fig. 12: Benefit of BAS

The collision speed was recalculated for all cases, independently of activation of BAS. The reduction in collision speed, as the possible effect of an activated BAS, was calculated as shown in Fig. 13. For non activation of BAS the collision speed was the same as before in the original dataset.

The effect of BAS leads to a change of collision speed.

Generally it is possible to reach a collision speed of 0km/h in certain cases, i.e., these accidents could be completely avoided due to BAS.

To determine the effect of primary safety systems, the influence in injury risk due to the change in collision speed was considered. Therefore the IRF was related to the recalculated collision speeds as the effect of BAS.

Potential of Primary Safety Systems “BAS”

To assess the effectiveness of the primary safety system BAS, the difference between the predicted numbers of at least seriously injured pedestrians of current situation and the situation after implementation of BAS in each car is decisively. That means the benefit is identified as number of saved at least seriously injured pedestrians if all cars are equipped with BAS.

If an accident was prevented with BAS, the predicted collision speed would have to be 0km/h. Another important fact is, that with this method a combined effectiveness of primary and secondary safety systems is ascertainable.

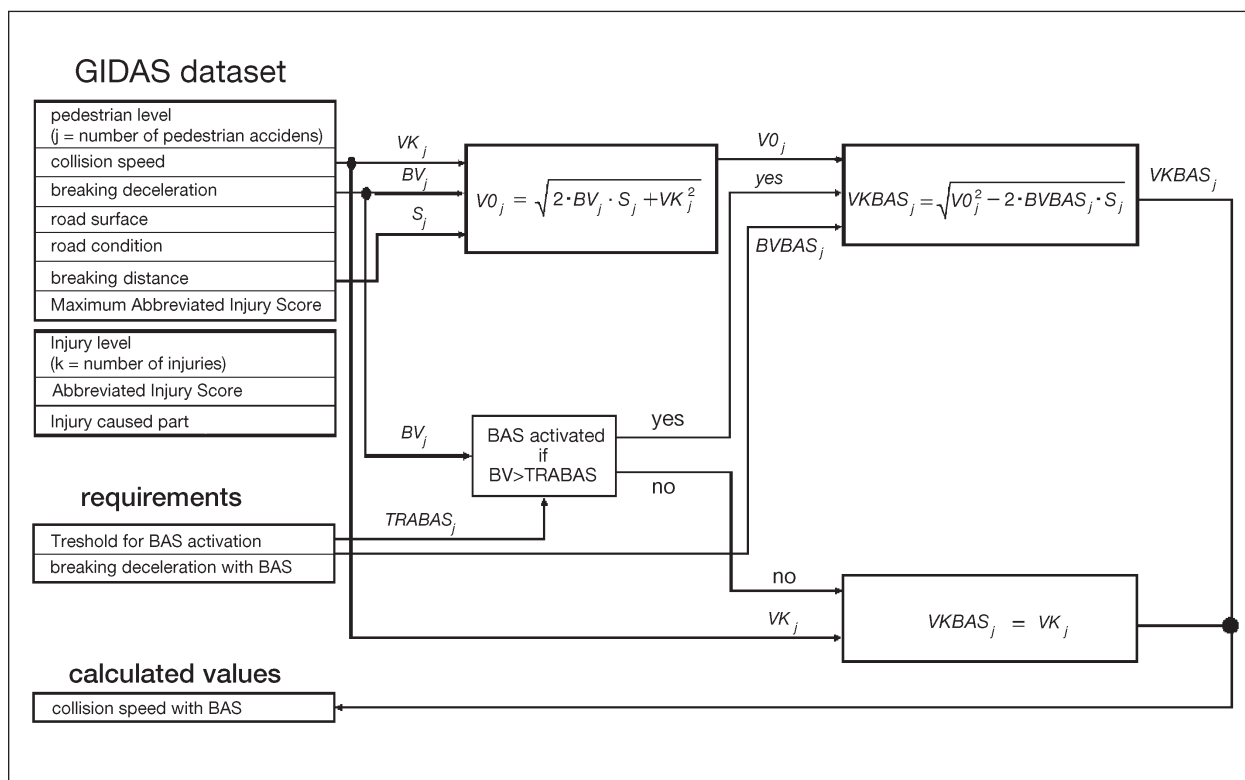

Fig. 13: Recalculation of collision speed with and without BAS

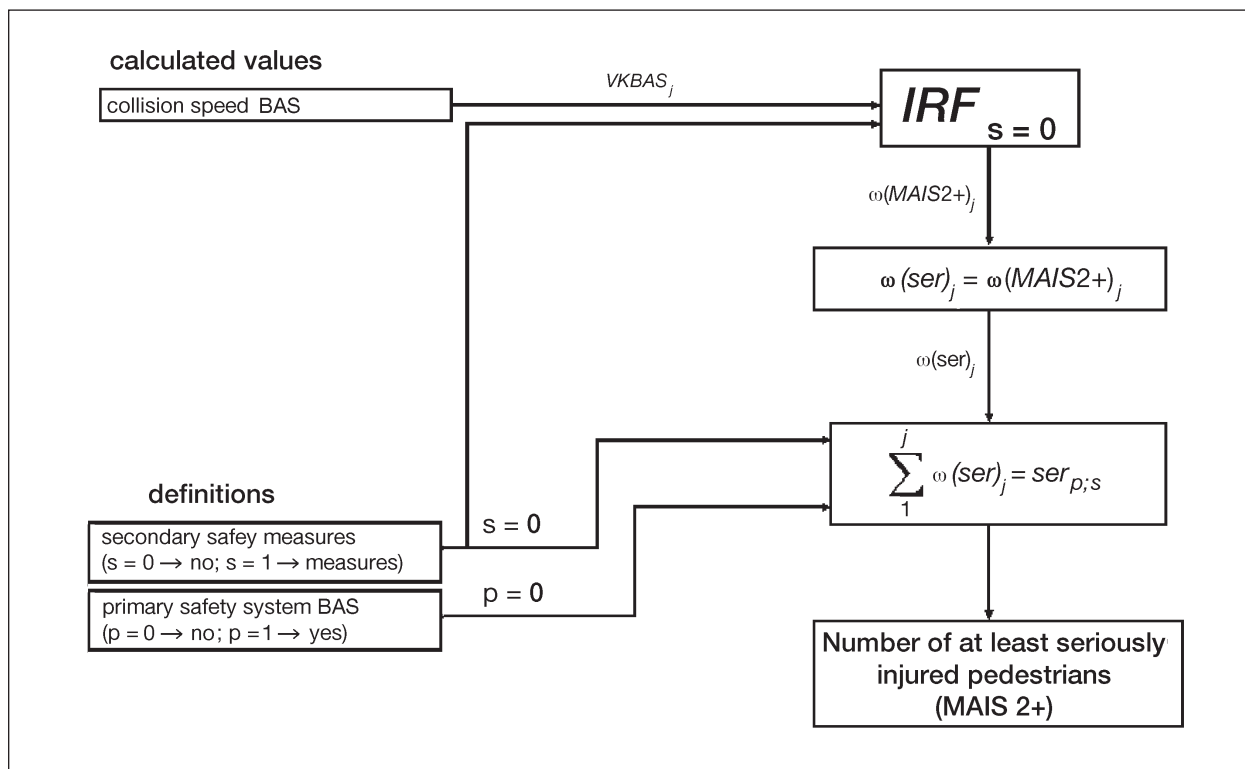

Fig. 14: BAS is equipped in all cars –number of at least seriously injured pedestrians